

250 A

1 000 V

U MAXI

DECONTACTOR™ DS2



IP66
IP67



70-95 mm² (1)
70-120 mm² (2)



METAL



IK10



-40 °C
+60 °C



AC-22
AC-23



60309-1
60309-4
60947-3



6 AUX. (3)



EMC

(1) Flexible wiring (min.-max.).
(2) Stranded wiring (min.-max.).
(3) Flexible wiring : 2,5 mm².

LOAD-BREAK CAPABILITY OF THE DECONTACTOR™

Comply with IEC/EN 60309-1 and IEC/EN 60309-4 standards	(250 A/500 V) or (200 A/690 V)
Load-break capability according to IEC/EN 60947-3/AC-22	(250 A/400 V) or (125 A/690 V)
Load-break capability according to IEC/EN 60947-3/AC-23	160 A/440 V
Short-circuit current I _{cc}	10 kA



Other configurations on request.



Each inlet should be connected to a wall box, a sleeve, a handle or a spacer to ensure correct operation of the closing mechanism.

SOCKET-OUTLET
female
DS2



INLET male
DS2

















380-440 V AC	3P+E	3924013	3928013
220-250 V AC 380-440 V AC	3P+N+E	3924017	3928017
660-690 V AC	3P+E	3924193	3928193
380-400 V AC 660-690 V AC	3P+N+E	3924197	3928197
1 000 V AC**	3P+E	3924223	3928223
Auxiliaries 5 A/400 V AC	+ 2 contacts	Ref. + 972	Ref. + 972
Auxiliaries 5 A/400 V AC	+ 4 contacts*	Ref. + 174	Ref. + 174
Auxiliaries 5 A/400 V AC	+ 6 contacts*	Ref. + 976	Ref. + 976



► Other currents, voltages, frequencies and contact configurations are available (see page 14).

* These versions cannot be ordered with neutral.







** Switch rating up to 150 A.

OPTIONS	Section de câblage	Reference
LOCKING PIN FOR 2 PADLOCKS Ø 4 TO 8 mm (PADLOCKS NOT SUPPLIED)		
		Socket-outlet ref. +843
SAFETY HASP FOR UP TO 6 PADLOCKS		
		399A541
ALLEN-SCREW LOCKING LATCH		
Direct latch locking, no padlocking option.		Ref. socket + 22
INLET CAP IP66/IP67		
		392A426
IP40 SELF RETURNING LID (MANUAL CLOSING)		
		Socket-outlet ref.+R
ELECTROMAGNETIC COMPATIBILITY (EMC) ● NEW		
	Please order a metal threaded accessory herewith, together with a EMC cable gland to be found on page 318.	
CABLE AMPLIFIER LUGS		
	Flexible 120 mm ² Stranded 150 mm ²	392A277150
	Flexible 150 mm ² Stranded 185 mm ²	392A277185
INCOMPATIBILITY ●		
	Those products marked with a red dot are incompatible with for use with amplifier ends.	
SPACERS (BETWEEN THE WALL BOX OR PANEL)		
	Depth 68 mm	5K7M0-68
	Depth 115 mm	5K7M0-115
PADLOCKING/ELECTRO-MECHANICAL INTERLOCKING		
	Socket-outlet reference+MIL. Check out the details on page 312	

SLEEVE	∠x°	Reference
METAL SLEEVE ●		
	0° (Straight)	596M0
	60°	596M6
	60°	597M6

BOXES	∠x°	Input	Reference
METAL BOX (+ EARTHING WIRE) + METAL SLEEVE + CORNET ●●			
	60°	M50	596E6M50
	60°	M63	596E6M63
	60°	M75	596E6M75
METAL BOX (+ EARTHING WIRE) + METAL SLEEVE + CORNET ●			
	60°	M63	597E6M63
	60°	M75	597E6M75

Cable glands are not delivered with the boxes.

HANDLE	Input/ Cable outer Ø	Reference
ELASTOMER HANDLE WITH GLAND		
	25-35 mm	556P0D35
	35-45 mm	556P0D45
	45-49 mm	556P0D49
POLY HANDLE + POLY CABLE GLAND		
	35-48 mm	516P063P
POLY HANDLE (WITHOUT CABLE GLAND)		
	M63	516P0M63
	M75	516P0M75
METAL HANDLE WITH INTEGRATED CABLE CLAMP		
	40-50 mm	5K6P0D50
	51-60 mm	5K6P0D60
	61-70 mm	5K6P0D70
	71-80 mm	5K6P0D80
	81-90 mm	5K6P0D90
METAL HANDLE METRIC THREAD ENTRY (WITHOUT CABLE GLAND) ●●		
	M50	596P0M50
	M63	596P0M63
	M75	596P0M75
METAL HANDLE METRIC THREAD ENTRY (WITHOUT CABLE GLAND) ●		
	M40	5K6P0M40L
	M50	5K6P0M50L
	M63	5K6P0M63L
	M75	5K6P0M75L
METAL HANDLE METRIC THREAD ENTRY (WITHOUT CABLE GLAND) - LARGE SIZE ●		
	M63	796P0M63
	M75	796P0M75

DRAWINGS AND DIMENSIONS

PLUG ON SOCKET-OUTLET

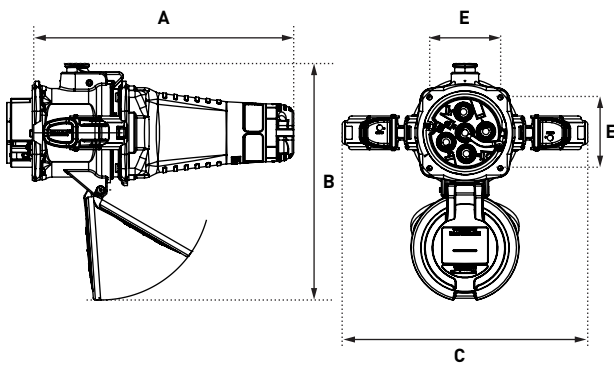

A	B	C	E
362	327	340	98

COUPLER

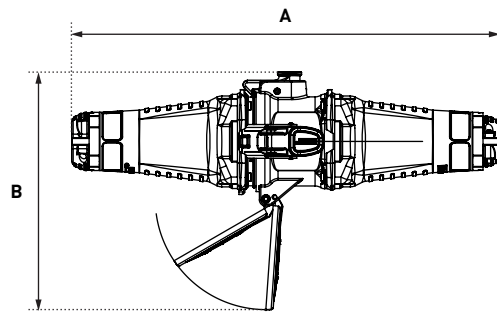

A	B
590	327

PLUG ON 60° WALL BOX MOUNTED SOCKET OUTLET

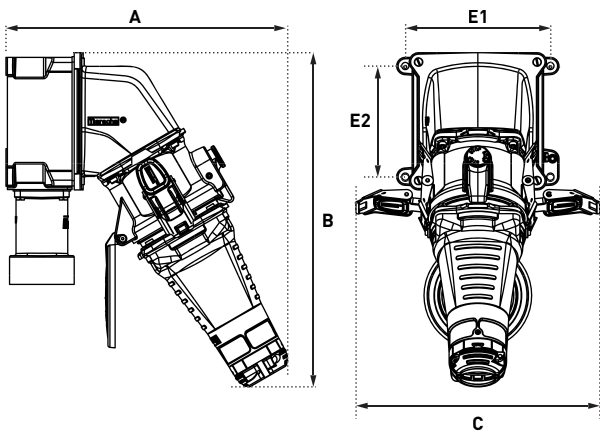

A	B	C	E1	E2
392	465	340	202	154

PLUG ON 60° INCLINED SOCKET OUTLET

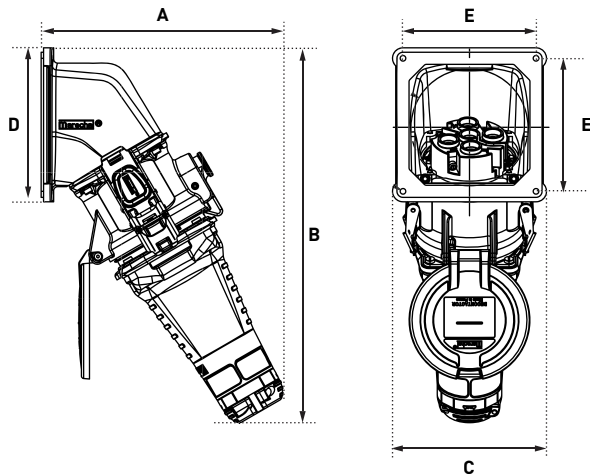

A	B	C	D	E
300	465	191	191	165



350 A 1 000 V

U_{MAXI}

INDUSTRIAL SOCKET OUTLET DS2



IP66
IP67



95 mm² ⁽¹⁾
95-120 mm² ⁽²⁾



METAL



IK10



-40 °C
+60 °C



2 PIL



EMC

⁽¹⁾ Flexible wiring (min.-max.).
⁽²⁾ Stranded wiring (min.-max.).



Padlocking system is standard.

OTHER FEATURES

Pilot wiring 2,5 mm²

* See our cable AMPLIFIER lugs for sections bigger than 95 mm² (flexible) or 120 mm² (stranded).



Each socket-outlet and each inlet should be connected to a wall box, a sleeve, a handle or a spacer to ensure correct operation of the closing mechanism.

SOCKET-OUTLET
female
DS2













INLET male
DS2





220-250 V AC	380-440 V AC	3P+N+E+2 pilots	3924017240	3928017240
380-400 V AC	660-690 V AC	3P+N+E+2 pilots	3924197240	3928197240

► Other currents, voltages, frequencies are available (see page 14).

OPTIONS	Cable section	Reference
SAFETY HASP FOR UP TO 6 PADLOCKS		
		399A541
ALLEN-SCREW LOCKING LATCH		
Direct latch locking, no padlocking option.		Ref. socket + 22
INLET CAP IP66/IP67		
		392A426
IP40 SELF RETURNING LID (MANUAL CLOSING)		
		Socket-outlet ref.+R
ELECTROMAGNETIC COMPATIBILITY (EMC) ● NEW		
	Please order a metal threaded accessory herewith, together with a EMC cable gland to be found on page 318.	
CABLE AMPLIFIER LUGS		
	Flexible 120 mm ² Stranded 150 mm ²	392A277150
	Flexible 150 mm ² Stranded 185 mm ²	392A277185
SPACERS (BETWEEN THE WALL BOX OR PANEL)		
	Depth 68 mm	5K7M0-68
	Depth 115 mm	5K7M0-115
PADLOCKING/ELECTRO-MECHANICAL INTERLOCKING		
	Socket-outlet reference+MIL. Check out the details on page 312	

HANDLE	Cable outer Ø (min./max.)	Reference
METAL HANDLE WITH INTEGRATED CABLE CLAMP		
	40-50 mm	5K6P0D50
	51-60 mm	5K6P0D60
	61-70 mm	5K6P0D70
	71-80 mm	5K6P0D80
	81-90 mm	5K6P0D90

HANDLE	Cable outer Ø (min./max.)	Reference
METAL HANDLE METRIC THREAD ENTRY (WITHOUT CABLE GLAND) ●		
	M40	5K6P0M40L
	M50	5K6P0M50L
	M63	5K6P0M63L
	M75	5K6P0M75L

HANDLE	Cable outer Ø (min./max.)	Reference
METAL HANDLE METRIC THREAD ENTRY (WITHOUT CABLE GLAND) - LARGE SIZE ●		
	M63	796P0M63
	M75	796P0M75

SLEEVE	∠ x°	Reference
METAL SLEEVE ●		
	60°	597M6

BOXES	∠ x°	Cable outer Ø	Reference
METAL BOX (+ EARTHING WIRE) + METAL SLEEVE + CORNET ●			
	60°	M63	597E6M63
	60°	M75	597E6M75

BOXES	∠ x°	Cable outer Ø	Reference
STAINLESS STEEL (+ EARTHING WIRE) + METAL SLEEVE + METAL CABLE GLAND (+ EARTHING WIRE)			
	70°	35-46 mm	577C763M
	70°	48-65 mm	577C775M

ELECTRICAL INTERLOCKING

At this level of power, it is not possible to break directly under load. Electrical interlocking with a switch or a pilot controlled contactor is required.

Boxes with the following equipment are available upon request:

- circuit breaker or differential switch,
- contactor,
- fuses,
- loop-out enclosures,
- terminals for single pole cables...

TYPICAL WIRING DIAGRAM OF THE DS2 CONTROL CIRCUIT

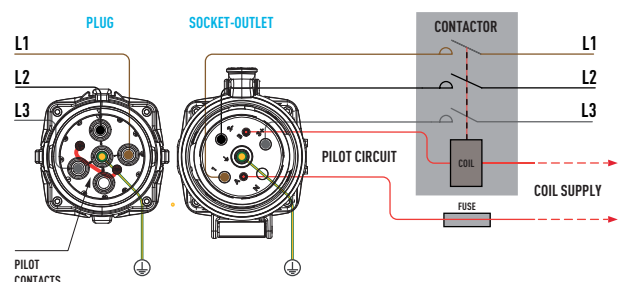

DRAWINGS AND DIMENSIONS

INLET

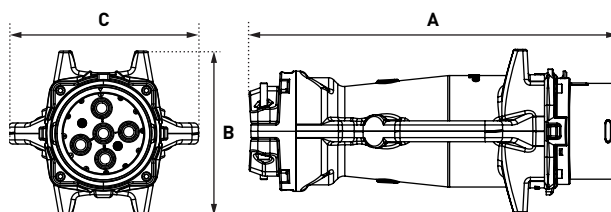

A	B	C
420	188	217

COUPLER SOCKET

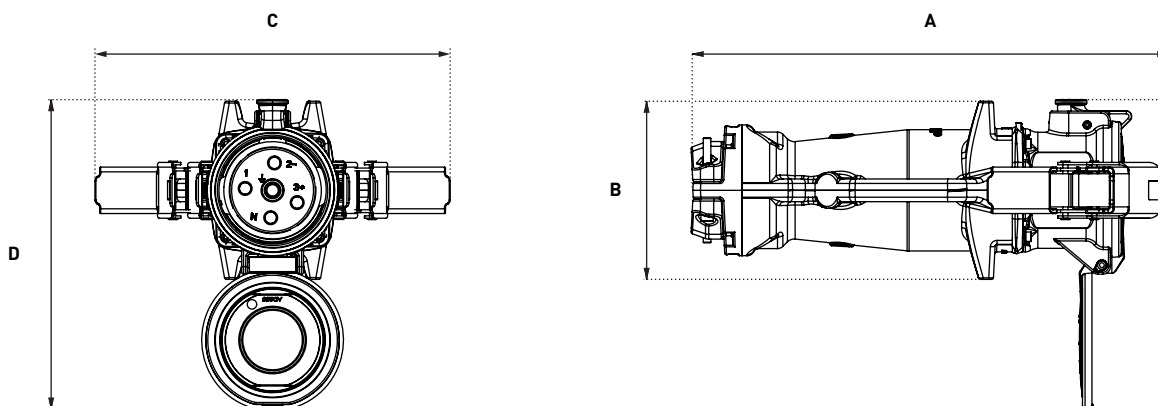

A	B	C	D
503	188	375	327

WALL BOX MOUNTED SOCKET-OUTLET 70°

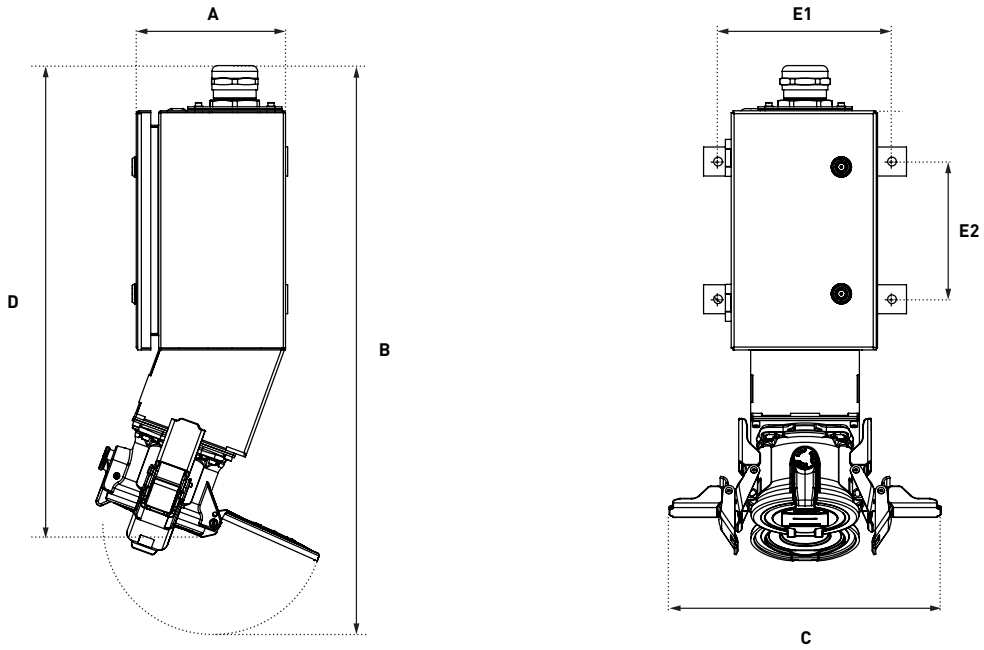

A	B	C	D	E1	E2
206	784	375	651	240	190

PANEL MOUNTED SOCKET-OUTLET 60°

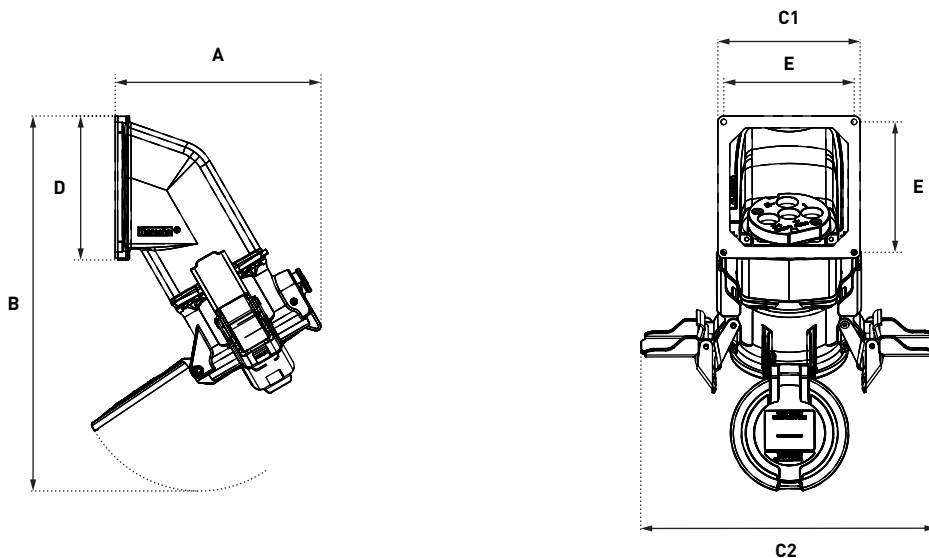

A	B	C1	C2	D	E
255	474	180	375	180	165